

# SPRT®

## SP-TL21N

### Thermal Label Receipt Printer

### User's Manual

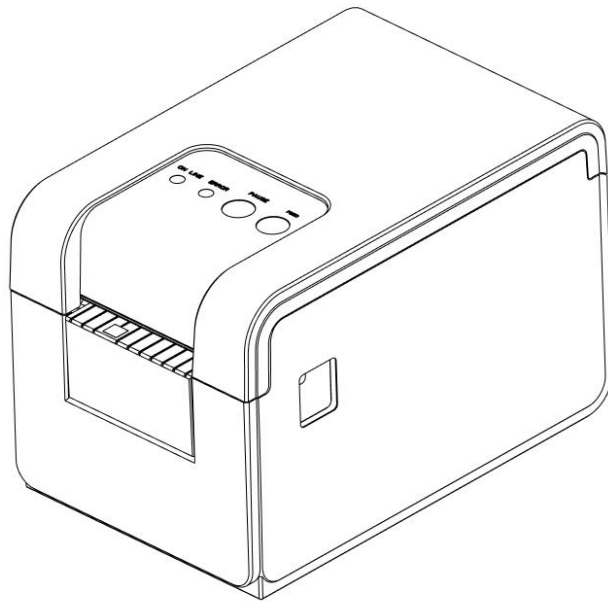

VER 1.01

Beijing Spirit Technology Development Co., Ltd

[www.sprt-printer.com](http://www.sprt-printer.com)

## Content

NOTICE.....	1
Chapter 1 Outer Appearance and Model No.....	2
1.1 Outer Appearance.....	2
1.2 Operation Panel.....	3
1.3 Model No.....	3
Chapter 2 Performance Characteristics.....	5
2.1 Printing Specification.....	5
2.2 Physical Parameters.....	5
2.3 Environmental Parameters.....	5
2.4 Other Specification.....	6
Chapter 3 Operation Method.....	6
3.1 Using Preparation.....	6
3.1.1 Paper Roll Installation.....	6
3.2 Basic function usage.....	7
3.2.1 Switch On.....	7
3.2.2 Switch Off.....	7
3.2.3 Self-Test.....	7
3.2.4 Paper Feeding (Manual Feeding).....	8
3.2.5 Hexadecimal Printing.....	8
3.2.6 Printer Parameters Setting.....	8
3.2.7 Printer Factory Reset.....	9
3.2.8 Printer Sensor Sensitivity Calibration.....	9
3.2.9 Set Into Upgrading Mode.....	10
3.2.10 Switch Working Mode.....	11
3.3 Printer Interface Connection and Printing.....	11
3.3.1 Power Connection.....	11
3.3.2 USB Connection.....	11
3.3.3 Bluetooth Connection.....	11
3.3.4 Serial Interface Connection.....	12
3.3.5 Cash Drawer Interface.....	13
3.4 Buzzer.....	13
3.5 Indicator light.....	13
Chapter 4 Other Information.....	14
4.1 Commands Manual.....	14
4.2 Description of pre-printed Black Mark.....	14
Appendix A.....	16

# NOTICE

Please read this manual carefully before using the printer!

## Notice of Safety

Be sure to use the power supply provided by our company. Otherwise it may cause damage to the product.

Please do not open the paper case cover when it is printing or just when printing is finished, do not touch the printer head with hand or any part of body to avoid excessive temperatures leading to burns.

## Notice of Using

Do not print the receipt with over 1m length. as this may damage the printer core.

Do not immerse the printer in water, or expose it to rain, as this can cause damage to the printer.

Do not open the paper case cover when it is printing, otherwise the printer may work improperly.

If printer is using USB connection to work, should not unplug the USB cable, or else some printing data may be lost. When printer is using bluetooth connection to work, the distance of communication should be within 10 meters, otherwise the printer doesn't print or prints rubbish codes.

Although the printer can work steadily when the environment temperature is between 0°C to 50°C, too high(45°C)or too low(5°C) environment temperature and too high (above 85% relative humidity) or too low (below 20% relative humidity) environment humidity both effect the printing quality.

The printer paper roll with poor quality or stored for too long time also may result in poor print quality even damage the printer.

Under the black mark detecting mode, the printer requires that the pre-printed black mark is accordant with the printing rule of black mark (please refer to details in Chapter 4.2), otherwise the black mark can not be detected correctly.

When the printer prints label paper, label should not over the maximum of the printer, otherwise the printer may work improperly.

## Notice of Storing

The printer should be stored at a temperature of -20 ° C to 60 ° C and a relative humidity of 10% to 90%.

### Declaration

**It is A class product, which may cause radio interference in the living environment. In this situation, users need to take feasible and effective measures to interfere with it.**

## Chapter 1 Outer Appearance and Model No.

### 1.1 Outer Appearance

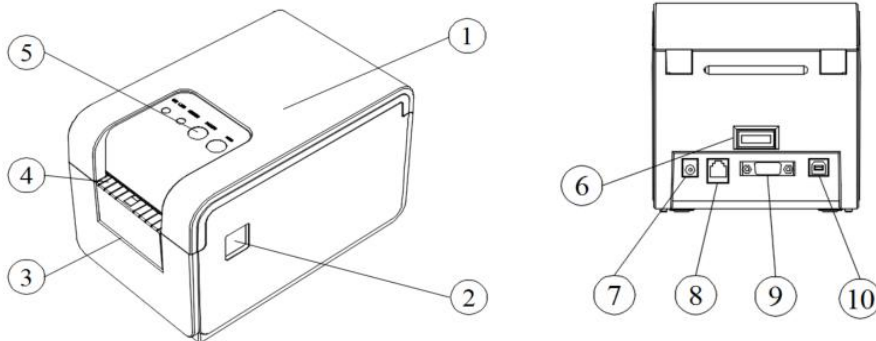

1	Printer cover
2	Cover open key
3	Backing paper outlet
4	Label paper outlet
5	Operation Panel
6	Power Switch
7	Power Interface
8	Cash Drawer Interface
9	DB9 Serial Port

10	USB Interface
----	---------------

## 1.2 Operation Panel

**ON LINE    ERROR    PAUSE    FEED**

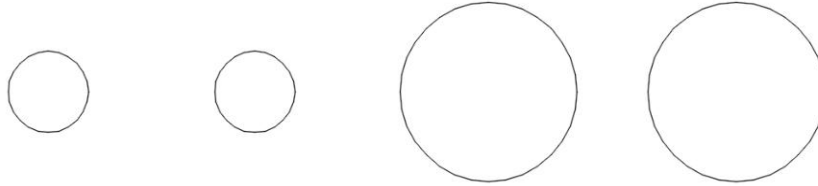

ONLINE/POWER指示灯  
ONLINE/POWER LED

ERROR指示灯  
ERROR LED

PAUSE按键  
PAUSE BUTTON

FEED按键  
FEED BUTTON

## 1.3 Model No.

SP-TL21N :default support USB, serial and Bluetooth three communication interfaces.

Model	Description
SP-TL21N	Support RS-232 and USB
SP-TL21NBTDM	Support RS-232, USB and Bluetooth(Double Mode)
SP-TL21NBTMM	Support RS-232, USB and Bluetooth(One to Many)
SP-TL21NWF	Support RS-232, USB and WIFI
SP-TL21NE	Support USB and Ethernet

## Chapter 2 Performance Characteristics

### 2.1 Printing Specification

Printing Method: Thermal line  
Paper Width: Max 57.5mm±0.5mm; Min 20mm±0.5mm  
Effective Printing Width: Max 56mm  
Max Label: 56x45mm;  
Resolution: 8dots/mm(203dpi)  
Dots in each line: 448mm/line  
Printing Speed: Max 127mm/s  
Paper Thickness: 0.06mm~0.08mm for normal paper and black mark paper  
0.12mm~0.14mm for label paper

Printable Content:

Character set: GB18030(Chinese) BIG5(traditional Chinese), GB12345(traditional Chinese), Shift+JIS(Japanese):24x24 and 16x16 dot matrix

ASCII: 12x24, 8x16, and 9x17 dot matrix

International character set and Code page: 12x24 and 9x17 dot matrix

Self-defined character and figure

Barcode:

1D:UPCA,UPCE,EAN13,EAN8,CODE39,ITF25,CODABAR,CODE93,CODE 128

2D: PDF417,QR CODE,DATA Matrix

### 2.2 Physical Parameters

Dimension (W×L×H): 197(L) X126(W) X132(H) mm

Physical Weight: 970g (excluding roll paper)

Paper Roll: 57.5x  $\phi$  80mm (max)

Interface: USB, RS-232, Bluetooth

Printing Head Life: 100km

### 2.3 Environmental Parameters

Operating Temp: 0°C~50°C

Operating Humidity: 10%~80%

Storage Temp: -20°C~60°C

Storage Humidity: 10%~90%

### 2.4 Other Specification

- Paper Loading Method: please refer to details in 3.1.1 Paper Roll Installation.

- Black Mark Location: available(details please see 4.2 pre-printed black mark manual).
- Printing Control Command: ESC/POS compatible command set, CPCL command set, TSC/TSCL command set  
(Refer to<SP-TL21 Printer Command Program Manual >for details).
- Power Supply: DV12V±5%, 2A

## Chapter 3 Operation Method

### 3.1 Using Preparation

#### 3.1.1 Paper Roll Installation

1. Press the cover open button. (Pic.1)
2. Take out the used paper roll and prepare a new one, and please mind the right direction of the paper. (Pic2)
3. Put the paper roll into the installation and pull out a part of paper, then shut down the cover.(Pic.3)
4. When use the function of automatic peel, please install as Pic.4 shows.

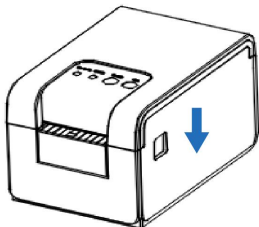

(Pic.1)

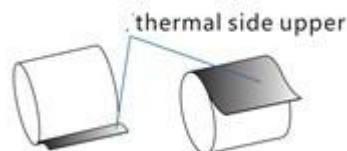

(Pic.2)

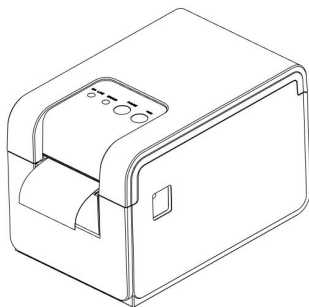

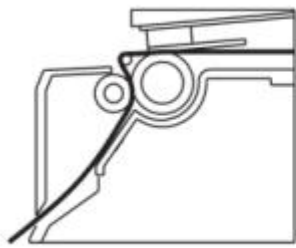

**True**  
**(Pic.3)**



**False**

**(Pic.4)**

## **3.2 Basic function usage**

Paper Type: Thermal paper, Black mark paper and Label paper.

Label Mode: Max 56mm wide, 45mm high paper supported, use label paper as default under label mode.

Receipt Mode: 48mm wide normal paper supported, use normal paper as default under receipt mode.

Set the Paper type by Setting Tool.

### **3.2.1 Switch On**

Press ' - ' on the button to turn on the printer, you will hear 'one low one high 'prompt tone, then the printer begin to work.

### **3.2.2 Switch Off**

Press ' 0 ' on the button to turn off the printer.

### **3.2.3 Self-Test**

After receiving the printer, users can check its current setting and status at anytime. Self-test method is as below: In the status of power off, then hold down the [FEED] button and press the power button at the same time. Then loosen the [FEED] button and Power button when you hear 'one low one high 'prompt tone, the current setting and status will be printed out.

### **3.2.4 Paper Feeding (Manual Feeding)**

Under the normal work status and using the thermal receipt paper, press [FEED] button, the paper feeding begins, and stops when loosen [FEED] button. When the printer uses black mark paper and label paper,



press[FEED]button, the printer begins to feed paper and stops over the position of black mark or label spacing. If the paper is not the black mark or label paper, the printer stops automatically after feeds paper for 4 inches(about 101mm). And also alarm the error of paper out if use label paper or black label mode. [FEED]button confirmed as paper feed button by default, which can be shielded or changed into print button by command.

### **3.2.5 Hexadecimal Printing**

The function of hexadecimal printing is to print the information received from host machine by hexadecimal numbers and corresponding characters. It will be convenient to debug application.

Into hexadecimal printing: Power off, press the[PAUSE]button and [MODE]button then press the power button at the same time. Then loosen these two buttons when you hear 'one low one high' prompt tone of power on. The printer print ' Hexadecimal Dump', printer prompted into hexadecimal printing mode.

Quit hexadecimal printing :The way to quit hexadecimal printing mode is switch off the printer or press the [FEED] button for three times to enter the normal working mode. When quit by pressing [FEED]button, '\*\*\*Completed\*\*\*' can be showed to indicate.

### **3.2.6 Printer Parameters Setting**

Printer support two methods to set printing parameters, button operation and setting tools. The method for setting tools can refer to documents for setting tool.

Under the status of power off, hold down the [PAUSE]button and [FEED]button, then press the power button. Then loosen the [FEED] button when you hear 'one low one high prompt tone of power on. Hold the [PAUSE] button and press the [FEED]button twice, the printer print 'Parameter setup mode' indicating into parameter setting mode. (Refer to Appendix A.)

Quitting parameter setting:hold down the [PAUSE]button, press the[FEED]buttons, then loosen [PAUSE] button and [FEED] button. Printer will save the set parameter and print 'Exit Set Mode', then exit the parameter setting mode and enter the normal working mode. The setting parameters won't be saved if you press the [POWER] button directly to turn off the printer.

B. Users can set more parameters by using the specification <SP-TL21 Setting Tools> software through computer. The setting includes: language, font, default code page, Bluetooth device name and password, printing mode etc. About the setting method please refer to the <SP-TL21Setting Tools Software Help>, offered with the software together.

### **3.2.7 Printer Factory Reset**

If printer can't work because of false parameter setting, please use the factory reset function to restore the setting parameter. Hold down the [PAUSE] button and [FEED] button, then press the power button. Then loosen the [FEED] button when you hear 'one low one high prompt tone of power on. Hold the [PAUSE] button and press the [FEED] button for three times, printer will print the current set parameter and indicate finally: 'Notice: it will restore system settings as default, press [FEED] once to confirm, power off directly to cancel.'

### **3.2.8 Printer Sensor Sensitivity Calibration**

Sensor have a default when printer leave factory. When the default don't match the paper, printer will have fault that can't detect paper status(for example: can't differentiate paper out status for thermal paper, can't differentiate the black mark or not, can't differentiate gap and label). Users can make the printer match with paper according calibration function.

In the status of power off, open the paper cover. Hold down the [PAUSE] button and power button, loosen the [PAUSE] button when you hear 'one low one high prompt tone, then close the cover when the buzzer ring. Printer will print 'Sensor Calibration Mode', which indicate the printer has entered sensor calibration mode. Press [FEED] button to calibrate, if the paper is compatible with printer, printer will calibrate the sensor to suitable value automatically after operating based on the printer suggestion, otherwise will not calibrate. Pinter will print different parameter based on the current paper mode, and the operation mode also will be different.

Label paper mode: Printer stops when feeds paper for 50cm. If the test passed, printer will print the detected sensor voltage information, and indicate 'label sensor test: normal', then quit after saving the parameter. If the test didn't pass, printer will indicate 'label sensor test: abnormal' and won't save any information.

Black mark paper: Printer stops when feeds paper for 50cm. If the test passed, printer will print the detected sensor voltage information, and indicate 'front side sensor test: normal'(front side is black mark in the current setting) or 'back side sensor test: normal'(back side is black mark in the current setting), then quit after saving the parameter. If the test didn't pass, printer will indicate 'front side sensor test: abnormal' or 'back side sensor test: abnormal' and won't save any information.

C. Thermal paper: Printer stops when feeds paper for 1cm and will indicate 'Please take the paper out and put the paper back when the buzzer ring'. Please operate based on printing indication. If the test passed, printer will print the detected sensor voltage information, and indicate 'continual paper test: normal', then quit after saving the parameter. If the test didn't pass, printer will indicate 'continual paper test: abnormal' and won't save any information.

### 3.2.9 Set Into Upgrading Mode

In the status of power off, press the [PAUSE] button and [FEED] button, then press the Power button. Loose the [FEED] button immediately when hearing 'one low one high 'prompt tone of power on, the [ERROR] indicator light flickering with the rate of 0.5Hz, then the printer enters upgrading mode, Please note that only USB and RS-232 interface can support online procedure upgrading.

### 3.2.10 Switch Working Mode

In the status of power off, press the [PAUSE] button and [FEED] button, then press the Power button, hear 'one low one high 'prompt tone, wait about 5seconds, printer print ' switch to receipt print mode' or 'switch to label print mode' ( printer will print different message according to the present working mode), then loose the button, printer will work on the indicated mode after restarting automatically.

## 3.3 Printer Interface Connection and Printing

### 3.3.1 Power Connection

Rated voltage is DC 12V±5%, rated current is 2A. Printer use desk type power socket, which the inner electrode is positive, the outside electrode is negative. Please use the standard configuration power adapter supplied by the manufacturer.

### 3.3.2 USB Connection

The standard accessories of SP-TL21 printer includes one standard USB D-type port cable which connects printer and host device. The USB of printer belongs to the slave device type. Pins appearance and definitions are as below:

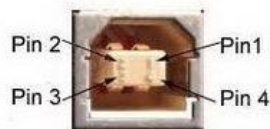

USB socket & definition

PIN NO	Function	Remarrk
1	V Bus	Power+5V
2	Data -	Data-
3	Data +	Data+
4	GND	ground

### 3.3.3 Bluetooth Connection

Hand-held device, laptop and other information terminal devices with

Bluetooth can drive SP-TL21 to print by the Bluetooth interface. SP-TL21 printer is compatible with Bluetooth2.0 standard. Power class is CLASS 1.5(SP-TL21BTMM) or CLASS 2.0(SP-TL21BTDM), effective communication distance is 10meters. The Bluetooth of the printer belongs to the slave device. The initial name of the printer is TL21 BT Printer, the initial password is '1234'; users can change the printer name and password by using<SP-TL21 Setting Tools> software. Please see the details in help file of <SP-TL21 Setting Tools>.

Before working, SP-TL21 Printer needs to be paired with bluetooth host device. Pairing begins from the host device. Usual pairing steps are as below:

1. Power on printer;
2. Host device searches for the outer Bluetooth device;
3. If there are other Bluetooth devices, please select TL21 BT Printer;
4. Enter the password '1234';
5. Pairing finished.

Please see details in host device Bluetooth function instruction for reference.

### Illustration:

The Bluetooth of SP-TL21 divided into dual mode Bluetooth and one-to-many Bluetooth. Dual mode Bluetooth supports one Android device and one IOS 4.0 device, only one device can connect with the printer at the same time. One-to-many Bluetooth supports three Android devices and one IOS device connect printer simultaneously.

### Notice:

1. When pairing, please make SP-TL21 printer switch on.
2. Once the Bluetooth of SP-TL21 has paired with the host Bluetooth device successfully, it can't be paired with other Bluetooth device until it unconnected with the host device.

### 3.3.4 Serial Interface Connection

The serial interface of TL21 is compatible with RS-232C, which support RTS/CTS & XON/XOFF handshake protocol. Its socket is DB-9 holes type. Pin definition are below:

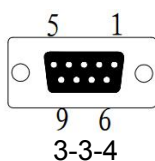

PIN NO	Signal Name	Origin	Definition
2	TXD	Printer	Printer send control code X-ON/X-OFF and data to host
3	RXD	Host	Printer receive data from host
6	DSR	Printer	Same as CTS
8	CTS	Printer	When the signal is 'Mark', it means printer is too busy to

			receive data, when the signal is 'SPACE', it means printer is ready to receive data
5	GND	—	GND

### 3.3.5 Cash Drawer Interface

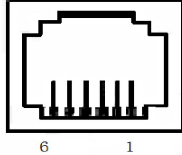

Fig 3-3-5 Cash drawer interface

PIN NO	Signal	Direction
1	Structure ground	—
2	Cash drawer driver signal	output
3	Cash drawer on/off status signal	input
4	+12V DC	—
5	NC	—
6	Signal ground	—

### 3.4 Buzzer

There is also a buzzer to indicate various status of the printer. The meanings are as below:

One low one high: power on;

Circulation continuous two lows: printer at error status

### 3.5 Indicator light

SP-TL21 has two indicator lights, the green one[ONLINE] is power light, the red one[ERROR] is status light.

The green indicator light[ONLINE] on when the printer on. The [ONLINE]light will flicker when the printer turn on the auto peel mode and paper left on the paper-taking position.

The red light[ERROR]off when the printer work properly, the meaning of red light are as below:

False	Status	Illustration
Paper out	On	Change paper or use the proper label paper
Paper cover open	Flicker twice and off for 1s	Close the paper cover
Over-heat printing head	Flicker once and off for 1s	Print after for a while

Bluetooth module error	Flicker for five times and off for 1s	Use the setting tools to set the matching Bluetooth module or return to manufacturer
------------------------	---------------------------------------	--------------------------------------------------------------------------------------

## Chapter 4 Other Information

### 4.1 Commands Manual

<SP-TL21N Commands Manual> is a technical manual for engineer to develop printer utility, and users can ask our company for it.

### 4.2 Description of pre-printed Black Mark

If user use pre-printed black mark to locate the receipt, please be sure to abide by the following pre-printed black mark regulation when print the black mark paper. Otherwise, it will cause that the printer cannot identify the black mark.

The black mark pre-print regulations are as below:

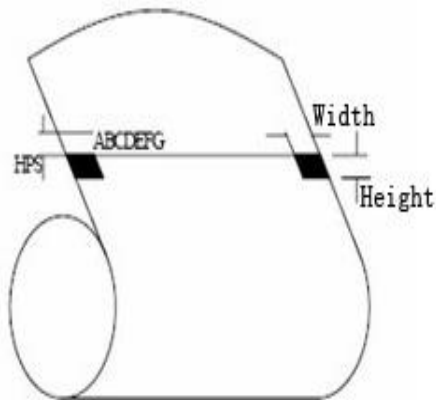

Printing Position: As the picture above, the black mark should be printed on the right edge of the side of words

Width range: width $\geq$ 7mm

Height range: 4mm $\leq$ height $\leq$ 6mm

Reflectivity of infrared ray : <10% (infrared ray reflectivity of other parts of the black mark paper is>65%)

HPS: It is the distance between edges of black mark and edges of print beginning position.

4.5mm $\leq$ Hps $\leq$ 6.5mm

## Appendix A

Setting introduction: Press[PAUSE]button to choose setting,when press it once , the set become the next one and it will print the present set value; use[FEED]button to set the set value, when press it once , the set become the next one and it will print the present set value.

After setting, press[PAUSE]and[FEED]button together, it'll save the current value, and printer enters into normal operation state. Otherwise it won't save the value.

### 1. General Setting:

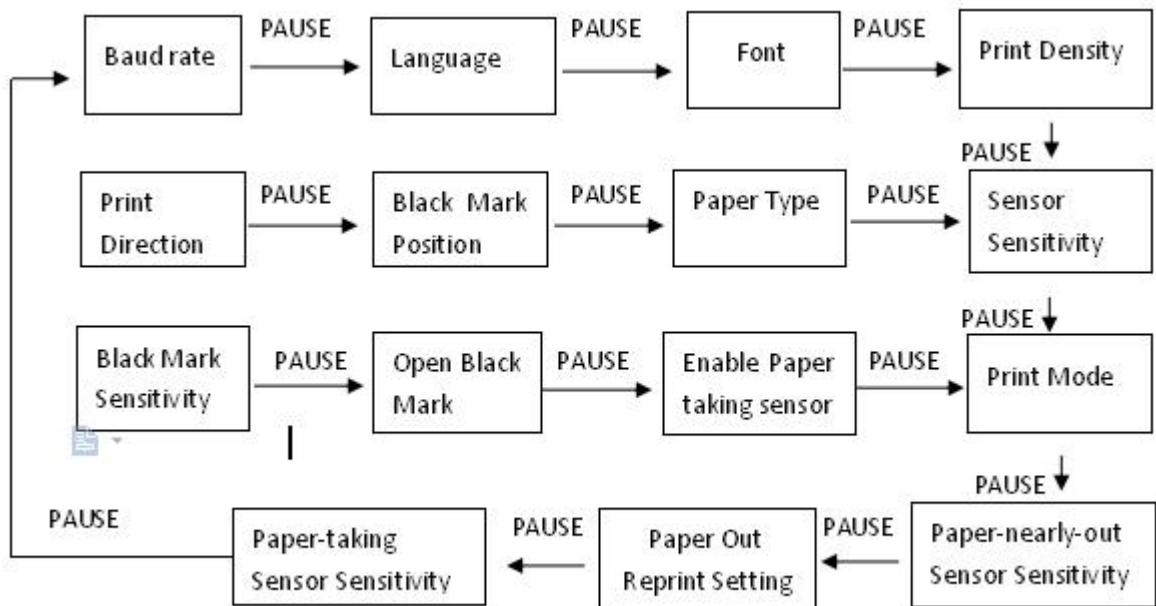

### 2. Baud Rate Setting:

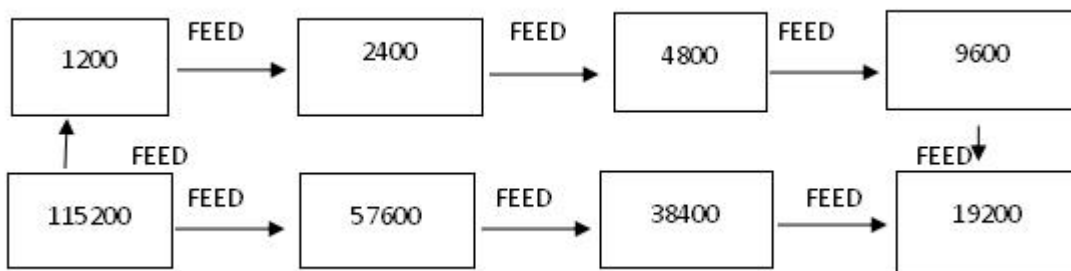

### 3. Language Setting

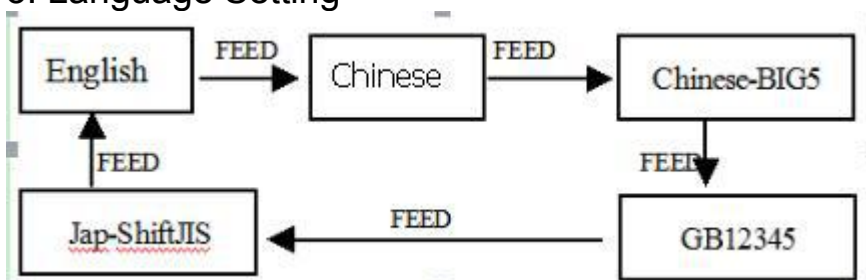

#### 4. Font Setting:

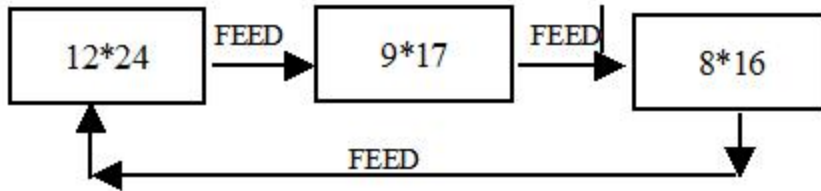

#### 5. Print Density Setting:

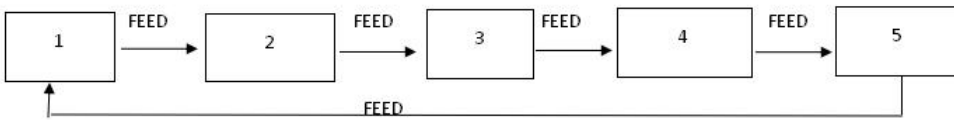

#### 6. Paper sensor sensitivity setting:

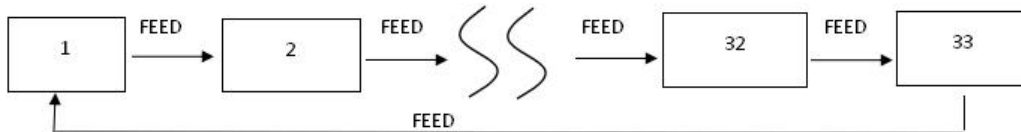

#### 7. Paper Type Setting:

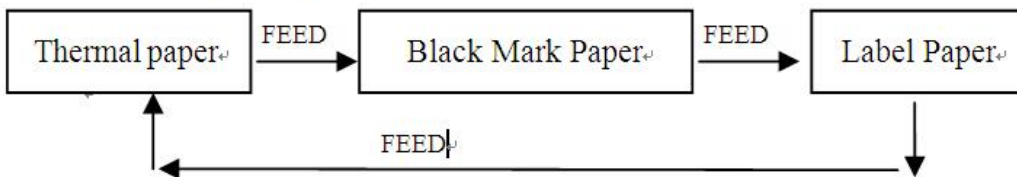

#### 8. Black Mark Position Setting

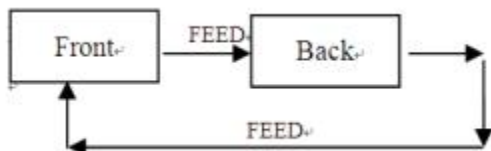

#### 9. Printing Direction Setting:

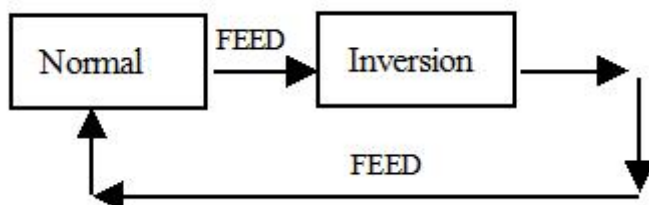



10. Black Mark Sensitivity Setting:

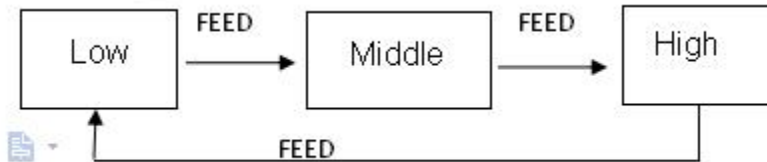

11. Enable Black Mark Setting:

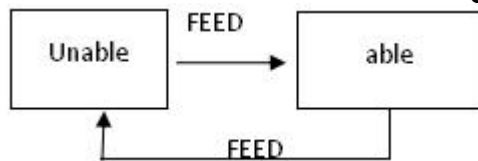

12. Paper-taking Sensor Sensitivity Setting:  
Same as Enable Black Mark Setting

13. Printing Mode Setting:

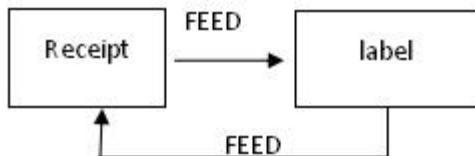

14. Paper Near-End Sensor Sensitivity Setting  
Same as Black Mark Sensitivity Setting

15. Paper Out Reprint Setting:  
Same as Enable Black Mark Setting

16. Paper-taking Sensor Sensitivity Setting:  
Same as Black Mark Sensitivity Setting

**Manufacture has right to amend the content of the instruction without prior announcement!**