

# SPRT®

## SP-L51

### Portable Thermal Printer

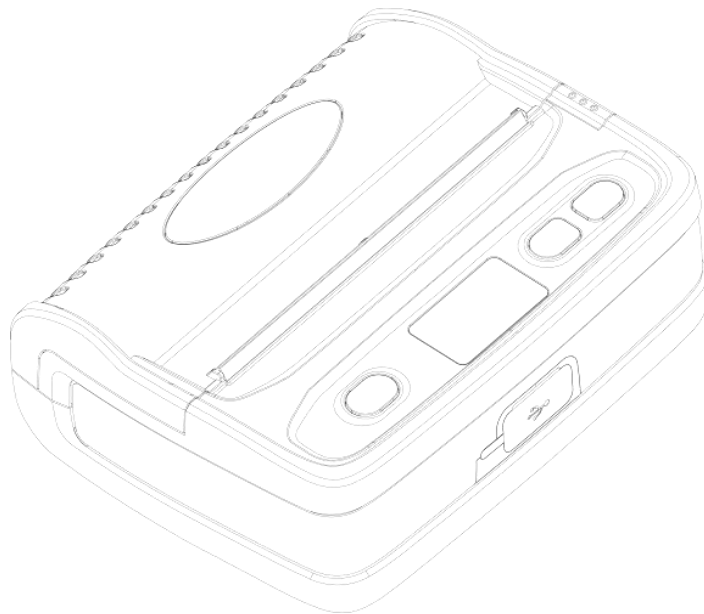

**User's Manual**  
**VER 1.02**

**Beijing Spirit Technology Development Co., Ltd**

**[www.sprt-printer.com](http://www.sprt-printer.com)**

# CONTENTS

NOTICE.....	1
Notice of Safety.....	1
Notice of Using.....	1
Notice of Storing .....	2
Chapter 1 Outer Appearance and Model No.....	2
1.1 Outer Appearance.....	2
1.2 Model No.....	3
Chapter 2 Characteristic Specification.....	4
2.1 Printing Specification.....	4
2.2 Physical Parameters.....	4
2.3 Environment Parameters.....	4
2.4 Other Specification.....	4
Chapter 3 Operation Method.....	5
3.1 Using Preparation.....	5
3.1.1 Battery Installation.....	5
3.1.2 Paper Roll Installation.....	5
3.1.3 Others.....	7
3.2 Basic function usage .....	7
3.2.1 Switch On .....	7
3.2.2 Switch Off .....	7
3.2.3 Self-Test .....	7
3.2.4 Paper Feeding (Manual Feeding).....	7
3.2.5 Hexadecimal Printing.....	8
3.2.6 Printer Parameters Setting.....	8
3.2.7 Battery Charging.....	9
3.2.8 Set Into Upgrading Mode.....	9
3.3 Printer Parameters Setting.....	10
3.4 Printer Interface Connection and Printing.....	10
3.4.1 USB Connection.....	10
3.4.2 Bluetooth Connection .....	10
3.5 Buzzer.....	11
3.6 LCD indication.....	12
Chapter 4 Other Information.....	13
4.1 Command Programming Manual .....	13
4.2 Description of pre-printed Black Mark .....	13
Appendix A.....	14
Appendix B.....	16

## **NOTICE**

Please read this manual carefully before using the printer!

### **Notice of Safety**

Be sure to use the specified battery and power supply provided by our company. Otherwise it may cause fire, explosion or damage printer, meanwhile, the battery also may be damaged.

Don't put battery into the fire, don't disassemble or heat the battery, don't be short circuit, it may cause fire, explosion or damage printer; meanwhile, the battery also may be damaged.

If the printer would not be used for a long time, be sure to take off the battery, otherwise the battery may leak liquid which is corrosive liquid,

If improper operation causes battery leak liquid, and it paste in the skin or clothes, please rinse it by clean water, if paste in the eyes, please rinse them thoroughly by clean water and see a doctor.

Please do not open the paper case cover when it is printing or just when printing is finished, do not touch the printer head with hand or body, overheat may cause scald.

### **Notice of Using**

Pls do not print the receipt with over 1m length. Otherwise, it may cause the damage of printing mechanism.

Water or other liquid should not be spilled into the printer, also the printer should not be appeared in the rain, or else may cause printer damage.

Please do not open the paper case cover when it is printing, otherwise the printer may work improperly.

If printer is using USB connection to work, should not unplug the USB cable, or else some printing data may be lost. When printer is using USB connection to work, the distance of communication should be within 10 meters, otherwise the printer doesn't print or prints rubbish codes.

Too high (50℃) or too low (.℃) environment temperature and too high (85%) or too low (20%) environment humidity both effect the printing quality.

The printer paper roll with poor quality or stored for too long time also may reduce the printing quality even damage the printer.

Under the black mark detecting mode, the printer requires that the

pre-printed black mark is accordant with the printing rule of black mark (please refer to details in Chapter 4.2), otherwise the black mark can not be detected correctly.

Be sure to use up the power of the battery before charge up it, as it can ensure the using life of the battery.

### Notice of Storing

The printer should be placed in such an environment that the temperature is between -20°C and 60°C, and the relative humidity is between 10% and 90%.

If the printer will be stored for a long time, please be sure to take out the battery, otherwise may damage the battery and printer.

### Declaration

**It is A class product, which may cause radio interference in the living environment. In this situation, users need to take feasible and effective measures.**

## Chapter 1 Outer Appearance and Model No.

### 1.1 Outer Appearance

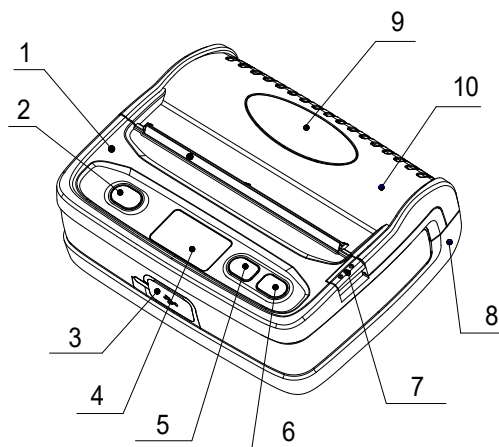

1	Cover Upper
2	Power Switch
3	Rubber Plug

4	LCD
5	Feed Button
6	Set Key
7	Cover Open Button
8	Lower Case
9	Transparency window
10	Paper Case Cover

## 1.2 Model No.

SP—L51BTDM/SP-L51BTMM  
Interface as default

Support USB and Bluetooth

## Chapter 2 Characteristic Specification

### 2.1 Printing Specification

Printing Method: Thermal line

Paper Width: 111.5mm±0.5mm , 104mm±0.5mm , 79.5mm±0.5mm, 57.5±0.5mm, 44±0.5mm

Effective Printing Width: 104mm, 100mm, 72mm, 48mm,37.5mm;

Resolution: 8dots/mm (203dpi)

Printing Speed: 80mm/s (thermal paper); 50mm/s (label paper)

Paper Thickness: 0.06-0.08mm(thermal paper), 0.06-0.15mm (label)

Printable Content:

Character set: GB18030(Chinese) BIG5(traditional Chinese), GB12345(traditional Chinese), ShiftJIS(Japanese), ASCII, Custom Charest, figure

Barcode:1D:UPCA,UPCE,EAN13,EAN8,CODE39,ITF25,CODABAR CODE93,CODE128

2D: PDF417,QR CODE,DATA Matrix

### 2.2 Physical Parameters

Dimension (W×L×H): 115 (L)X147 (W)X53.5(H)mm

Physical Weight: 500g (excluding roll paper)

Paper Width: 112mm, 100mm, 80mm, 58mm and 44mm

Paper Roll Diameter: Max 40.0mm

Interface: USB, Bluetooth

Printing Head Life: 50km

### 2.3 Environment Parameters

Operating Temp: 0°C~50°C

Operating Humidity: 10%~80%

Storage Temp: -20°C~60°C

Storage Humidity: 10%~90%

### 2.4 Other Specification

- Paper Loading Method: drop-in easy paper loading ( please refer to details in 3.1.2 Paper Roll Installation).
- Tear paper: manual
- Black Mark Location: available(details please see 4.2 pre-printed black mark manual).

- Printing Control Command: ESC/POS compatible command set/CPCL command set  
(Refer to <L51 Printer Command Program Manual >).
- Power Supply: 7.4VDC/2300mAh rechargeable polymer lithium battery.
- Power Alarm: when the battery is low, the battery indicator on LCD blinks
- Battery Charging: quick charging, it will be charged full about 4 hours;
- Auto Sleep: printer will auto sleep when it have not received printing data or key operation in 5 seconds, press FEED button/MODE button/Power switch or printer receive any printing data in auto-sleep period will wake up the printer.
- Battery Duration: under 25% printing density, at least 200 meters, the standby time is over 7 days. (These parameters are just for reference; long term usage will cause the capacity decline, and cannot ensure the time of printing.)

## Chapter 3 Operation Method

### 3.1 Using Preparation

#### 3.1.1 Battery Installation

1. Put the battery into the battery slot from the side with pins and press the other side into case. (as below Pic.)

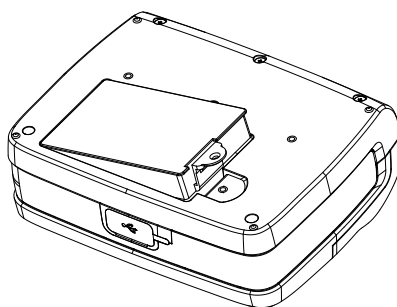

#### 3.1.2 Paper Roll Installation

1. Press the cover open button. (Pic.1)
2. Push the auto paper roll installation from the middle to the two ends (Pic2), put a new paper roll into the installation, and please mind the direction of the paper roll. (Pic.3&Pic4)

3. Pull out a part of paper and put the end of the paper in the middle of the paper out orifice.
4. Shut down paper case cover and cut off the redundant paper
5. Repeat Step 3~4.



(Pic.1)

Paper roll in the middle and suit paper  
with different width automatically



(Pic.2)

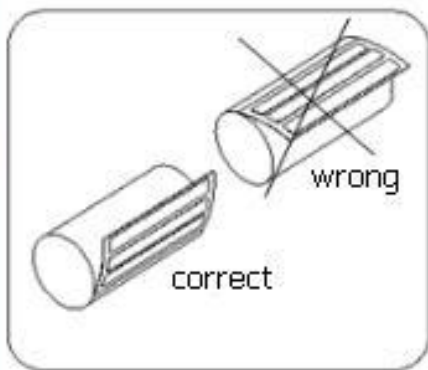

(Pic.3)



(Pic.4)



### 3.1.3 Others

Open and close the door slowly with both hands.

Abnormal operation: Paper blocking is not allowed at the outlet.

Placement direction: Hand-held flat printing when printing, to ensure the stability of the paper roll as far as possible.

## 3.2 Basic function usage

Paper Type: Thermal paper, Black mark paper and Label paper.

Standard Mode: Standard 112mm mode, Standard 110mm mode, Standard 80mm mode, Standard 58mm mode, Standard 44mm mode. Use standard label paper as default under Standard mode. Set the Paper type and print mode by Setting Tool.

### 3.2.1 Switch On

Press **【POWER】** button then you will hear 'one low one high' prompt tone. The LCD shows "Loading...", then the printer turns into work mode when loosen the **【POWER】** button. The LCD shows printer parameter.

### 3.2.2 Switch Off

Under status of switch on, the printer will send out the prompt tone of 'one high one low' after pressed the **【POWER】** button, the LCD turns off, then loosen the **【POWER】** button, the printer is off.

### 3.2.3 Self-Test

After receiving the printer, user can check its current setting and status at anytime. Self-test method is as below: Power off, then hold down the **【FEED】** button and press the power button at the same time. Then loosen the **【FEED】** button and Power button when you hear 'one low one high' prompt tone and LCD shows "Loading...", the current setting and status will be printed out.

### 3.2.4 Paper Feeding (Manual Feeding)

Under the normal work status and using the thermal receipt paper, press **【 FEED 】** button, the paper feeding begins, and stop when loosen **【 FEED 】** button. When the printer uses black mark paper and label paper, press **【 FEED 】** button, the printer begins to feed paper and stops over the position of black mark or label spacing. If the paper is not the black mark or label paper, the printer stops automatically after feeds paper for 30cm. And also alarm the error if under label paper mode.

### **3.2.5 Hexadecimal Printing**

The function of hexadecimal printing is to print the information received from host machine by hexadecimal numbers and corresponding characters. It will be convenient to debug application. Into hexadecimal printing: Power off, hold down the **【 MODE 】** button and press the power button at the same time. Then loosen the power button and press the **【 FEED 】** button when you hear 'one low one high' prompt tone of power on and LCD shows "Loading...". After that you may loosen the **【 MODE 】** button and **【 FEED 】** button. The printer turns into the hexadecimal printing mode and print the presentation.

Quit hexadecimal printing :The way to quit hexadecimal printing mode is switch off the printer or press the **【 FEED 】** button for three times and to enter the normal working mode. The printer will also print the presentation which shows that the printer have quit hexadecimal printing mode.

### **3.2.6 Printer Parameters Setting**

Set simple printing parameters according button operation. There are two methods of entering into parameter setting mode, which can set different parameters.

A. Under the state of power off, hold down the **【 MODE 】** button then press the **【 POWER 】** . Then loosen the **【 POWER 】** button and **【 MODE 】** button orderly when you hear 'one low one high prompt tone and LCD shows "Loading...". The printer turns into the parameters setting mode. Press the **【 FEED 】** button or **【 MODE 】**

button, LCD shows the first item which can be set parameters and the current numerical value. (Refer to Appendix A.)

Quitting parameter setting:hold down the 【MODE】 button, press the 【FEED】 buttons, then loosen 【MODE】 button and 【FEED】 button. Saving the set parameter and exiting the parameter setting mode. The setting parameters won't be saved if you directly press the 【POWER】 button to turn off the printer.

B. Under the state of standby power, press the 【MODE】 button to enter the parameter setting mode. Use the 【MODE】 button and 【FEED】 button in combination. Press the 【MODE】 button to select the setting parameter item, and use the 【FEED】 button to select the sub-menu of parameter item.(Refer to Appendix B.)

Wait for 5 seconds to save parameters value and quit the setting mode automatically.

### **3.2.7 Battery Charging**

The battery will run out after a period of usage. When it nearly runs out, printer will give a alarm through the battery indicator flashing on LCD, at this time, user needs to charge up the battery

The charging method is as following: connecting the adapter to the power socket with 220V, 50HZ, then plug the power charging plug to the power socket of the printer, so the power charging begins. During the course of power charging, the charging indicator 【CHARGE】 goes red, and 【CHARGE】 turns to green when the charging is full. Please don't use printer when it's charging.

### **3.2.8 Set Into Upgrading Mode**

In the status of power off, press the 【MODE】 button and 【FEED】 button, then press the Power button, hear 'one low one high 'prompt tone, loose all the button immediately, then the printer enters upgrading mode, the LCD shows upgrading mode.

Please note that only USB interface can support online procedure upgrading.

### 3.3 Printer Parameters Setting

Users can set more parameters by using the specified 〈 SP-L51 Setting Tools 〉 software through computer. The setting includes: language、font、printing density、default code page、Bluetooth device name and password, printing mode etc. About the setting method please refer to the <SP-L31Setting Tools Software Help>, offered with the software together.

### 3.4 Printer Interface Connection and Printing

#### 3.4.1 USB Connection

The standard accessories of SP-L51 printer includes Mini USB cable which connects printer and main device. The USB type belongs to the slave device type. Pins description of Mini-USB as below:

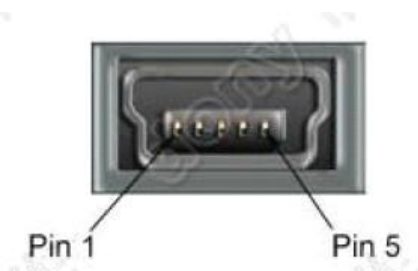

Pin	Function	Notes
1	V Bus	Power +5V
2	Data-	Data-
3	Data+	Data-
4		Blank
5	GND	Ground

Mini USB Socket and Pin Definition

#### 3.4.2 Bluetooth Connection

Hand-held device, laptop and other information terminal devices with Bluetooth can drive SP-L51 to print by the Bluetooth interface. SP-L51 portable printer is compatible with Bluetooth2.0 standard. Power class is CLASS 2, effective communication distance is 10meters. The Bluetooth of the printer belongs to the slave device. The initial name of the printer is L51 BT Printer, the initial password is '1234'; users can change the printer name and password by using<SP-L51 Setting Tools> software. Please see the details in help file of <SP-L51 Setting Tools>.

Before working, SP-L51 Portable Thermal Printer needs to be paired with primary device. Pairing begins from the host device. Usual

pairing course is as below:

1. Power on printer;
2. Host device searches for the outer Bluetooth device;
3. If there are other Bluetooth devices, please select L51 Printer;
4. Enter the password '1234';
5. Pairing finished.

Please see details in primary device Bluetooth function instruction for reference.

### **Illustration:**

The Bluetooth of SP-L51 divided into dual mode Bluetooth and one-to-many Bluetooth. Dual mode Bluetooth supports one Android device and one IOS device, only one device can connect with the printer at the same timer. One-to-many Bluetooth supports six Android devices and one IOS device connect printer simultaneously.

### **Notice:**

- 1, When pairing, please make SP-L51 printer switch on.
2. Once the Bluetooth of SP-L51 has paired with the host Bluetooth device successfully, it can't be paired with other Bluetooth device until it unconnected with the host device.
3. Bluetooth Icon on printer LCD shows the connection status after paired successfully.

### **3.5 Buzzer**

There is also a buzzer to indicate various status of the printer. The meanings are as below:

One low one high: power on;

One high one low: power off;



Circulation continuous two lows: printer at error status

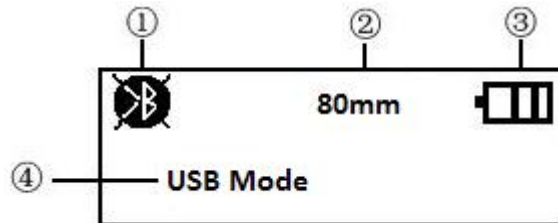

### 3.6 LCD indication

Turn on the printer, the LCD shows “Loading...”, and shows the relevant information after printer initialization. If printer didn't receive any data or connect with any device within 5seconds, the display will turn off showing automatically. But it'll show again until printer receive data or connect with device.

1. Standard mode:



① When the icon is , it means there's no Bluetooth connection; When the icon is , it means the Bluetooth is on connecting state.  
② It shows the different paper type, 112mm, 100mm, 80mm, 58mm and 44mm.

③ The current capacity level of printer battery icon. The different icons  shows the current battery level. When it comes to low battery level, it'll become to show this icon  with flickering

④ Text indication display. Printer current state is showed by text.  
It shows USB mode when the printer have not connected with external device.

It shows USB connected when the printer connect with main device via USB.

It shows USB communicating when the printer received data via USB connection.

It shows Bluetooth connected when the printer connect with main device via Bluetooth and open the corresponding port.

It shows USB and Bluetooth connected when the printer connect with main device via both Bluetooth and USB.

It shows Bluetooth communicating when the printer received data via Bluetooth connection.

## Chapter 4 Other Information

### 4.1 Command Programming Manual

<SP-L51 Technical Manual> is a technical manual for engineer to develop printer utility, and users can claim our company for it.

### 4.2 Description of pre-printed Black Mark

If user use pre-printed black mark to locate the receipt, please be sure to abide by the following pre-printed black mark regulation when print the black mark paper. Otherwise, it will cause that the printer cannot identify the black mark.

The black mark pre-print regulations are as below:

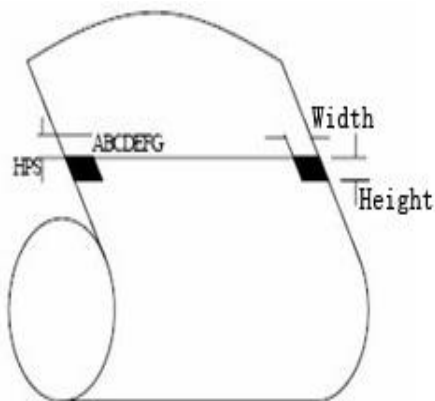

Printing Position: As the picture above, the black mark should be printed on the right edge of the side of words (both sides of the paper is available).

Width range:  $\text{width} \geq 7\text{mm}$

Height range:  $4\text{mm} \leq \text{height} \leq 6\text{mm}$

Reflectivity of infrared ray :  $< 10\%$  (infrared ray reflectivity of other parts of the black mark paper is  $> 65\%$ )

**HPS:** It is the distance between edges of black mark and loading position.

$4.5\text{mm} \leq \text{Hps} \leq 6.5\text{mm}$

## Appendix A

Setting introduction: Press **【MODE】** button to choose setting, when press it once, the set become the next one and it will print the present set value; use **【FEED】** button to set the set value, when press it once, the set become the next one and it will print the present set value.

After setting, press **【MODE】** and **【FEED】** button together, it'll save the current value, and printer enters into normal operation state. Otherwise it won't save the value.

General Setting:

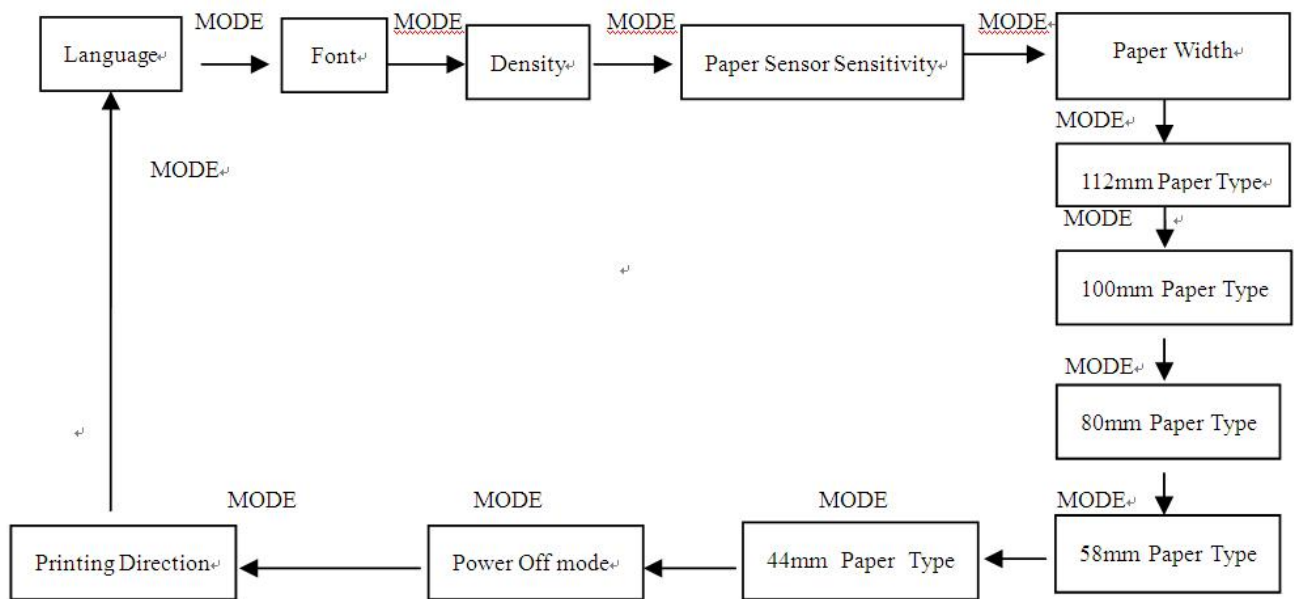

Language setting

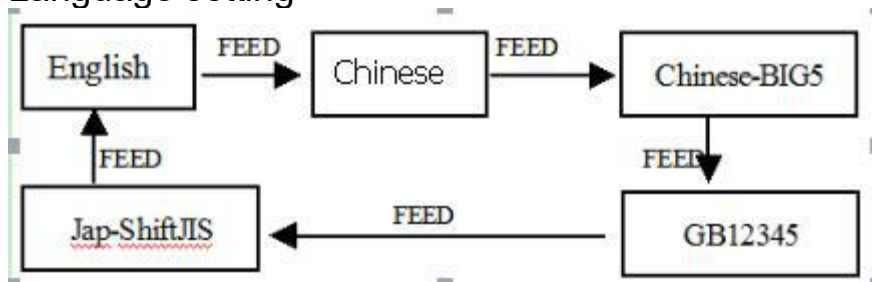

Font Setting:

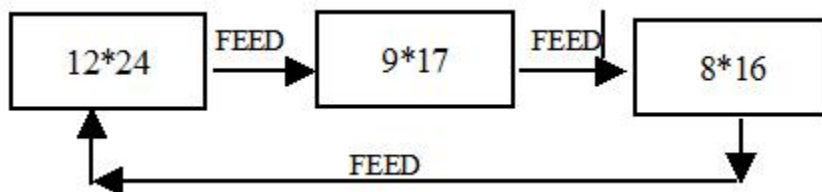



Paper sensor sensitivity setting:

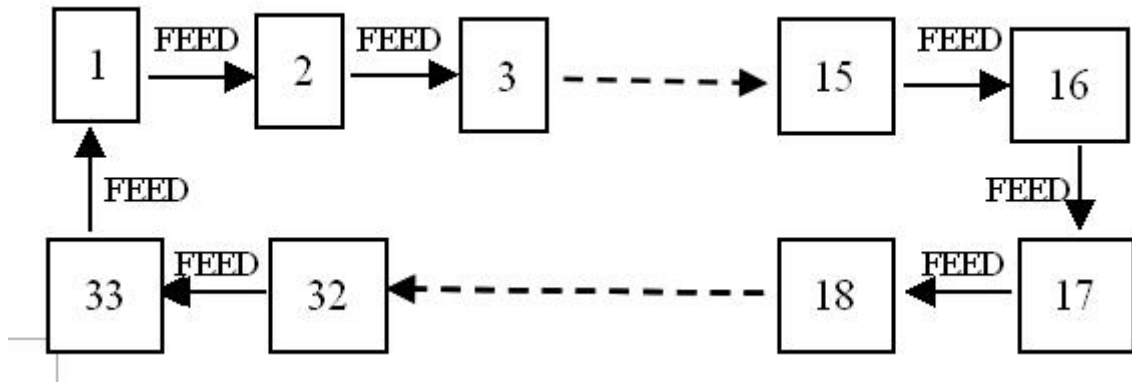

44mm Paper Type Setting:

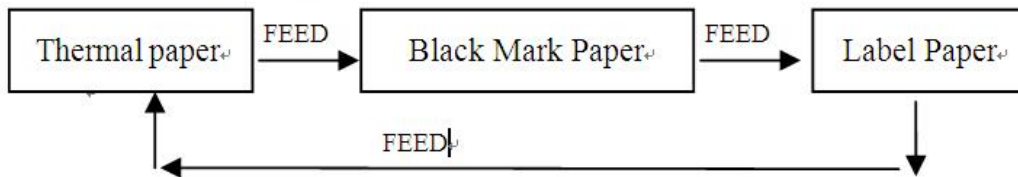

112mm/100mm/80mm/58mm Paper type Setting

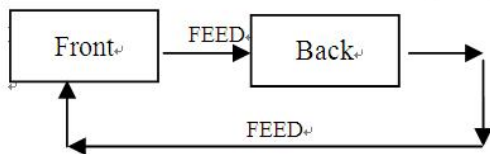

Power off Setting:



Power off Setting:

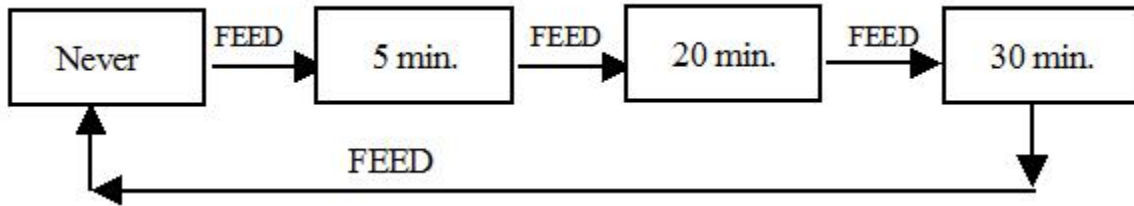

Printing Direction Setting:

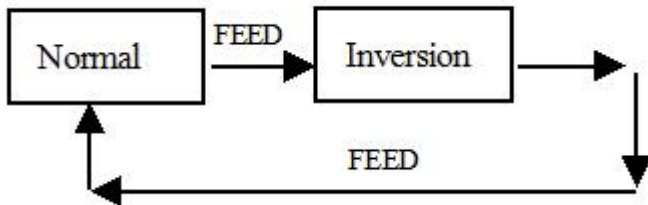

## Appendix B

Setting introduction: Press **【MODE】** button to choose setting, when press it once, the set become the next one and it will shows the present set value; use **【FEED】** button to set the set value, when press it once , the set become the next one and it will print the present set value.

After setting, it'll quit the Setting mode automatically and save the current value after 5 seconds.

General Setting:

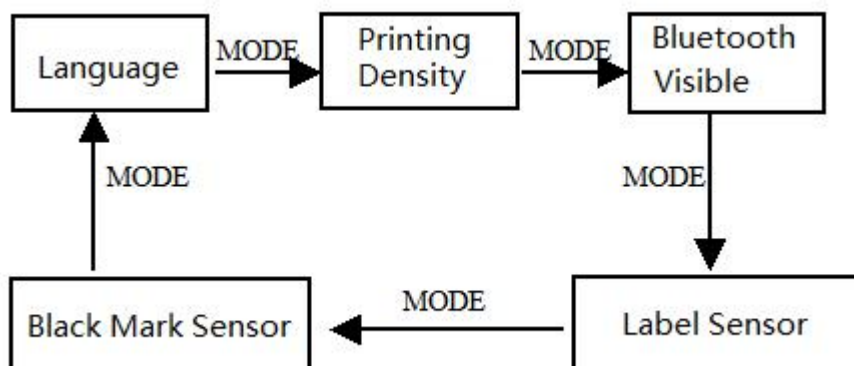

Language Setting:

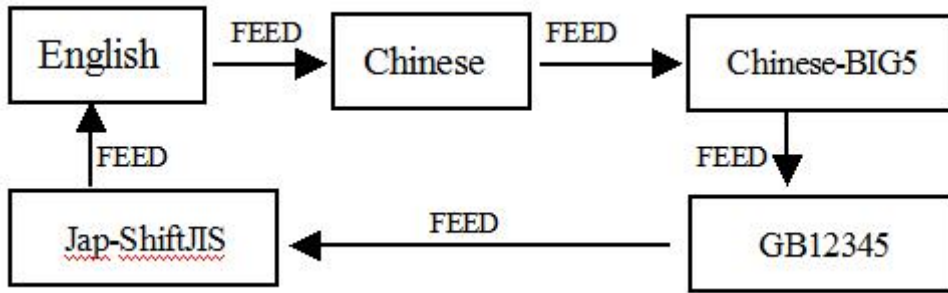

Density Setting:

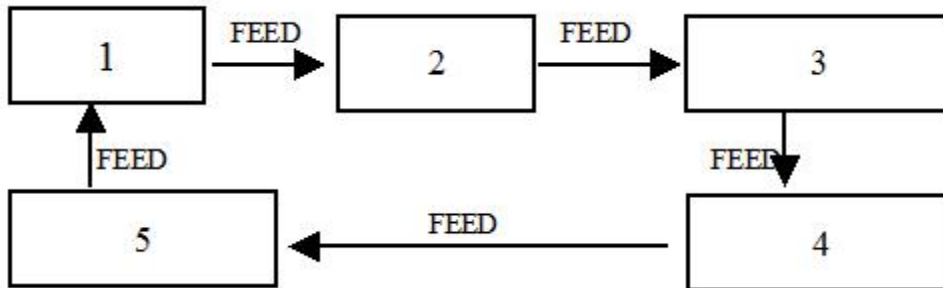

Visible Bluetooth Setting:

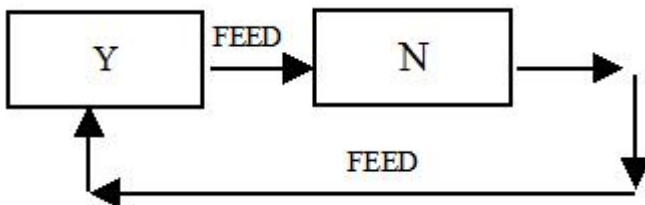

Label Sensor Setting:

Under standard mode, set as label paper under paper mode. Press **【MODE】** button, adjust the setting items to label sensor setting, then press **【FEED】** button, the printer will feed paper by 260mm, and print out the self-test paper for max power voltage, min voltage, set threshold voltage and the voltage difference value between the max and min voltage. It'll save the value after 5 seconds.

## Black Mark Sensor Setting:

Put the 44mm black mark paper directly into printer under Logistics mode ( set as black mark paper under Standard mode). Press 【 MODE 】 button, adjust the setting items to black mark sensor setting, then press 【 FEED 】 button, the printer will feed paper by 260mm, and print out the self-test paper for max power voltage, min voltage, set threshold voltage and the voltage difference value between the max and min voltage. It'll save the value after 5 seconds.

**Manufacture has right to amend the content of the  
instruction without prior announcement!**