

SPRT®

POS Thermal Receipt Printer

(POS8810)

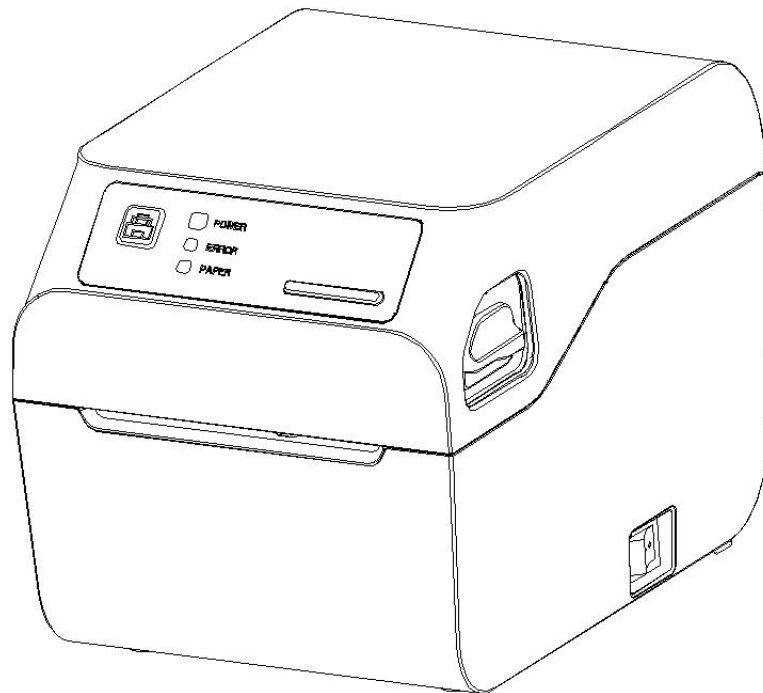

User's Manual

(Ver 1.02)

Beijing Spirit Technology Development Co.,Ltd.

www.sprt-printer.com

Content

| | |
|--|----|
| NOTICE..... | 1 |
| Notice of Safety..... | 1 |
| Notice of Using..... | 1 |
| Notice of Storing..... | 2 |
| Introduction..... | 2 |
| Chapter 1 Feature and Performance..... | 3 |
| 1.1 Print Performance..... | 3 |
| 1.2 Print Paper..... | 3 |
| 1.3 Print Font..... | 3 |
| 1.4 Interface..... | 4 |
| 1.5 Print Control Commands..... | 4 |
| 1.6 Power Supply..... | 4 |
| 1.7 Operation Environment..... | 5 |
| 1.8 Outline Dimension..... | 5 |
| 1.9 Model classification..... | 5 |
| Chapter 2 Operation Specification..... | 6 |
| 2.1 Printer Appearance..... | 6 |
| 2.2 Paper Installation..... | 7 |
| 2.2.1 Paper Loading..... | 7 |
| 2.2.2 Solution to Paper Jam..... | 7 |
| 2.3 Interface..... | 7 |
| 2.3.1 Serial interface..... | 7 |
| 2.3.2 LAN interface..... | 8 |
| 2.3.3 USB Interface..... | 9 |
| 2.3.4 Bluetooth Interface..... | 9 |
| 2.3.5 WIFI interface..... | 10 |
| 2.3.6 Cash Drawer Interface..... | 11 |
| 2.3.7 Power Connection..... | 12 |
| 2.4 Buttons and Indicators..... | 12 |
| 2.5 Power on status..... | 15 |
| 2.6 Self-test..... | 15 |
| 2.7 Hexadecimal Printing..... | 17 |
| 2.8 Parameter Setting..... | 17 |
| 2.9 Enter the program upgrade mode..... | 17 |
| Chapter 3 Printer Driver Installation..... | 18 |
| Appendix A..... | 19 |

NOTICE

Please read this manual carefully before using the printer!

Notice of Safety

- ◆ Do not touch the tear bar of the printer
- ◆ Do not touch the print head and its connecting parts to avoid burns or damage to the print head due to static electricity.
- ◆ If the printer emits smoke, odor, or abnormal noise, turn off the machine immediately. Continued use may cause a fire. The power should be turned off immediately and contacted by the dealer or the SRPT Customer Service Center for instructions.
- ◆ Do not disassemble the printer by yourself. Improper repairs are dangerous and will break the promise of warranty by supplier.
- ◆ Use the power adapter supplied by the supplier or that meets the specifications. Improper power adapters may damage the machine and cause a fire.
- ◆ Prevent other objects entering into the printer to avoid damage of components. Foreign objects may even cause a fire or accident.
- ◆ If water or other liquids flow into the printer, immediately turn off the power and contact the dealer immediately to inquire about the handling method. Continued use may cause a fire.

Notice of Using

- ◆ Water or other liquid should not be spilled into the printer, also the printer should not be appeared in the rain, or else may cause printer damage.
- ◆ Please do not open the paper case cover when it is printing, otherwise the printer may work improperly.
- ◆ If printer works with USB connection, USB cable should not be pulled out during the printing process. Otherwise the data will be incomplete. When printer works with Bluetooth connection, the distance of communication should be within 10 meters, otherwise the printer doesn't print or prints messy code.
- ◆ Although the printer can work steadily when the environment temperature is between 0°C to

50°C, too high(45°C)or too low(5°C) environment temperature will affect printing quality.

◆Too high (above 85% relative humidity) environment humidity or too low (below 20% relative humidity) environment humidity will effect the printing quality.

◆ The printer paper roll with poor quality or stored for too long time also may reduce the printing quality, sometimes even damages the printer.

◆ When the printer works in the black mark detection mode (when printing pre-printed receipts with black marks), the black mark pre-printed on the printing paper is required to comply with the black mark printing specifications (refer to Appendix B: Pre-printed black mark instructions for details), otherwise It may cause the printer to fail to accurately detect the black mark.

Notice of Storing

The printer should be placed in such an environment that the temperature is between-20°C and 60°C, and the relative humidity is between 10% and 90%.

Introduction

SP-POS8810 printer is a new type line thermal printer, it features in fast speed print, low print noise, high reliability, perfect print quality and ribbon needless, avoiding the vexation of regular maintenance.

SP-POS8810 printer: small in outline dimension, simple operation, and extensive application, especially suitable for commercial cash register, PC-POS, bank POS and all kinds of receipts print.

Warning

This is a class A product. In a domestic environment this product may cause radio interference in which case the user may be required to take adequate measures.

Chapter 1 Feature and Performance

1.1 Print Performance

- Print method: direct thermal
- Print paper width: 79.5±0.5mm
- Print density: 8 dots/mm, 576 dots/line
- Print speed: max 200mm/s (25% density)
- Reliability
 - (1) Print head life: 150km
Using condition:
 - * Print 12 × 24 ASCII characters, print 50 lines each time, intermittent print repeatedly
 - * Use specified thermal paper
 - (2) Cutter life: 1500,000 cuts
 - (3) Valid print width: 72mm

1.2 Print Paper

- Thermal paper roll model: TF50KS—E (Japan paper co.ltd)
AF50KS-E (JUJO THERMAL)
- Thermal paper roll: Paper Type— — Thermal Paper 80mm x ϕ 80mm (max)
Inner Diameter— — — ϕ 13mm (min.)
Thickness — — — 0.06mm~0.08mm

1.3 Print Font

- ANK Character Set
12×24 dots, 1.5 (W) × 3.00 (H) mm
- GB GB2312-80(Chinese):
24×24 dots, 3.00 (W) × 3.00 (H) mm.

1.4 Interface

- RS-232C serial interface (optional):

DB9 socket (hole type), supports XON/XOFF and DTR/DSR protocols.

Baud rate: 1200, 2400, 4800, 9600, 19200, 38400, 57600, 115200bps adjustable.

Data structure: 1 start bit + (7 or 8) data bit + 1 stop bit.

Parity: no parity or odd and even parity optional.

- Ethernet Interface: Normal Ethernet interface.

- USB Interface: USB interface

- Bluetooth interface (optional):

Dual-mode Bluetooth interface.

- Cash Drawer Control

DC24V, 1A, 6-pin RJ-11 socket.

- WIFI interface (optional):

Support 802.11b/g/n wireless standard (2.4GHz).

1.5 Print Control Commands

- Character print commands: support double-width, double height print of ANK characters, user-defined characters and Chinese characters, the character line spacing is adjustable.

- Graphics print commands: support the print of bit-map graphics and download bit-map graphics with different density

- GS barcode print commands:

Support UPC-A, UPC-E, EAN-13, EAN-8, CODE39, ITF25, CODEBAR, CODE93, CODE128, PDF417, QR code, DATA Matrix code print.

1.6 Power Supply

- DC24V±10%, 2A, DC005-2.5 power socket

1.7 Operation Environment

- Operation temperature: 0~50°C; Relative humidity: 10~80%
- Storage temperature: -20~60°C; Relative humidity: 10~90%

1.8 Outline Dimension

- 179(L)mm×140(W) mm×138 (H)mm
- Weight: 1120g (without paper)

1.9 Model classification

| Model | Interface |
|--------------------|---|
| SP-POS8810UE | USB Interface, LAN Interface, Cash Drawer Interface |
| SP-POS8810M | USB Interface, LAN Interface, Cash Drawer Interface, RS232C serial Interface |
| SP-POS8810UEW | USB Interface, LAN Interface, Cash Drawer Interface, WIFI |
| SP-POS8810UEWVT | USB Interface, LAN Interface, Cash Drawer Interface, WIFI |
| SP-POS8810UEBTDMVT | USB Interface, LAN Interface, Cash Drawer Interface, BTDM (Dual-mode Bluetooth) |

Chapter 2 Operation Specification

2.1 Printer Appearance

The names of the various parts of the printer are shown in Figure 2-1

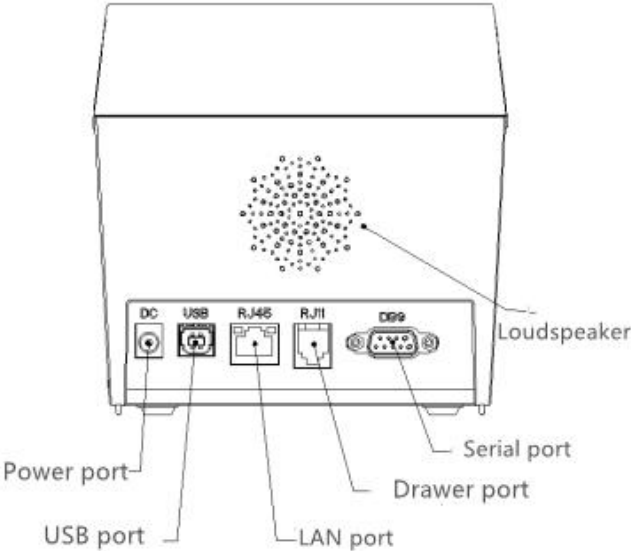
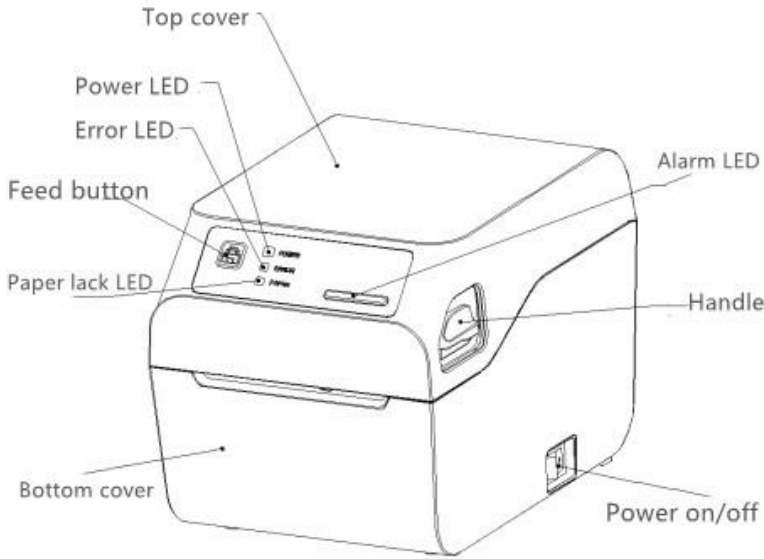

Figure 2-1 The name of each part of the printer

2.2 Paper Installation

2.2.1 Paper Loading

SP-POS8810 printer uses 79.5±0.5mm wide thermal paper roll.

The thermal paper installation steps are as follows:

Raise the door opener to open the cover, insert the paper shaft through the paper roll core (when there is a paper shaft), pull out part of the paper and put the paper roll into the paper shaft card slot inside the paper bin, and place the protruding paper on. On the movement, align the paper parallel to the paper exit direction of the movement, and close the upper shell tightly with a little force.



1. Pay attention to the direction of loading the paper roll so that the printing side faces the machine head.
2. Do not use your hand to move the paper forward or backward.
3. Keep clean of the print head, avoid to influence the printing quality.

2.2.2 Solution to Paper Jam

If the cutter is jammed, you can pull up the door opener to open the shell, and the cutter will automatically return to its original position. If there is a paper jam, the cutter can open the shell and take out the paper.

2.3 Interface

2.3.1 Serial interface

The serial interface of the SP-POS8810 printer is compatible with RS-232C and supports RTS/CTS and XON/XOFF handshake protocols. The interface seats a DB-9 socket. The

definition of each pin is shown in Figure 2-2.

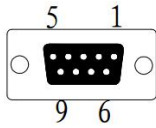

Figure 2-2

| Pin number | Signal name | Source | Explanation |
|------------|-------------|---------------|--|
| 2 | TXD | Printer | The printer sends the control code X-ON/X-OFF and data to the host |
| 3 | RXD | Host computer | The printer receives data from the host |
| 6 | DSR | Printer | Same as CTS |
| 8 | CTS | Printer | When the signal is in the "MARK" state, it means that the printer is "busy" and cannot receive data, and when the signal is in the "SPACE" state, it means that the printer is "ready" and can receive data. |
| 5 | GND | — | Signal ground |

2.3.2 LAN interface

The model with Ethernet interface use RJ45 Network socket. The appearance is as Fig.2-2 shows:

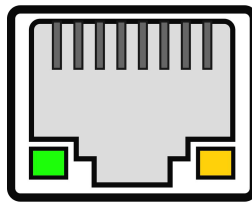

Fig.2-3 LAN cable interface

Models with network ports can be configured for DHCP or static IP connection, and the printer uses static IP connection by default. The DHCP operation method is as follows:

1. Turn on DHCP: Press and hold the [FEED] key and turn on the [Face] to turn on the machine. After turning on the key, do not release the key. Release the [FEED] key after the status indicator and the out of paper indicator flash alternately. Then press the [FEED] key three times, close the

[Front Cover], and the printer's network port can be configured to DHCP mode.

The method of obtaining the network port parameters in this mode is as follows: turn on the [Face], press the [FEED] key once, and close the [Face], the printer will immediately print out the current network parameters (IP and other parameters) of the network port.

2. DHCP off: Press and hold the [FEED] key and turn on the [Face] to turn on the machine. After turning on the key, do not release the key. Release the [FEED] key after the status indicator and the out of paper indicator flash alternately. Press the [FEED] key four times again, close the [Face], the printer's network port parameters will be restored to the factory default settings, you can turn off the DHCP mode.

Note: The above operations need to be completed when the printer has paper.

2.3.3 USB Interface

The standard configuration of the SP-POS8810 printer is equipped with a standard USB printer cable D-type data connection cable, which is used to connect the printer and the main device. The printer's USB belongs to the type of slave device (DEVICE); the appearance and pin definitions are shown in 2-4:



Fig.2-4 USB interface

| Pin | Function | Notes |
|-----|----------|--------------|
| 1 | V Bus | Power +5V |
| 2 | Data- | Data- |
| 3 | Data+ | Data+ |
| 4 | GND | Power Ground |

2.3.4 Bluetooth Interface

Handheld devices, notebook computers, or other information terminals with Bluetooth interface can drive SP-POS8810 to print through the Bluetooth interface. The Bluetooth of the SP-POS8810 printer is compatible with Bluetooth 4.2 Bluetooth specification, the power level is

CLASS 1.5 (SP-POS8810UEBTDMVT model), and the effective distance is 10m. The Bluetooth of the printer belongs to the slave device. The initial device name is POS8810 Printer, and the initial password is "1234". The user can use the <SP-POS8810 Setting Tool Software> to modify the device name and password as needed. For details on how to change the device name and password, please refer to the help file of the <SP-POS8810 Setting Tool Software>.

Before printing, POS8810 printer needs to pair with the host firstly. The pairing process is as below:

1. Turn on the printer
2. The host searches the Bluetooth devices
3. If several Bluetooth devices are found, pls choose POS8810 Printer.
4. Input password "1234".
5. Complete pairing.

Please refer to the Bluetooth function description of the master device for the specific pairing method.

Note: The Bluetooth of SP-POS8810 printer is dual-mode Bluetooth. Dual-mode Bluetooth supports Android devices and Apple 4.2 devices, and only one device can be connected to the printer at the same time.

- (1) During pairing, the SP-POS8810 printer must be turned on.
- (2) Once the printer's Bluetooth device is successfully paired with the host Bluetooth device and a link is established, it will no longer provide search and link services for other master Bluetooth devices until it disconnects from the host device that links it.

2.3.5 WIFI interface

The printer supports 2.4G WiFi module communication function, and the printer supports WeChat distribution network function, which can quickly realize the connection between the printer WiFi and the router; the specific operation steps through WeChat distribution network are as follows:

1. Press and hold the [FEED] button and open the cover, then turn on the printer. Release the [FEED] button after the status indicator and the out of paper indicator flash alternately. Then

press the [FEED] key seven times, close the cover, the printer enters the intelligent network configuration mode, and the network configuration QR code will be printed out. At this time, the network configuration operation can be performed, and the [PAPER] blue light will flash for one second Flashes at intervals.

2. Make sure that the mobile phone is connected to the router and the network is normal. Use the mobile phone WeChat to scan the QR code on the bottom of the printer to enter the network configuration interface, and click the "Start Network Configuration" button.

3. Enter the password of the router connected to the mobile phone, and then click the "Connect" button. The printer will start to configure the network. After the network is configured successfully, the printer will automatically connect to the router. At the same time, it will print the IP address. In the local area network, users can send data to the printer through this IP address.

4. If the printer has completed the network configuration, the network configuration information will be automatically saved, and the next time the machine is turned on, it will automatically connect Wifi. When it connected successful, the [PAPER] blue indicator light will stop flashing and become steady on.

2.3.6 Cash Drawer Interface

The cash drawer interface of SP-POS8810 adopts RJ-11 6-pin socket, as Fig.2-5 shows:

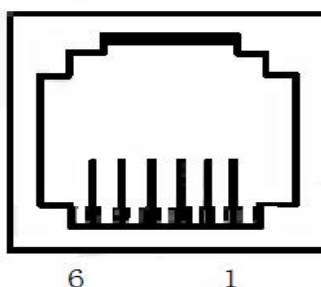

Fig.2-5 Cash Drawer Interface

The pin assignment is as below:

| Pin No. | Signal | Direction |
|---------|-----------------------------|-----------|
| 1 | Chassis Ground | — |
| 2 | Cash drawer driver signal 1 | Out |

| | | |
|---|----------------------------------|-----|
| 3 | Cash drawer on/off status signal | In |
| 4 | +24VDC | — |
| 5 | Cash drawer driver signal 2 | Out |
| 6 | Signal ground | — |

2.3.7 Power Connection

SP-POS8810 uses the external power supply adopter as $24V \pm 10\%$, 2A, and it uses DC005-2.5 power socket, positive inside and negative outside. Please use the standard power adapter for power supply. The appearance and pin definition are shown in Figure 2-6:

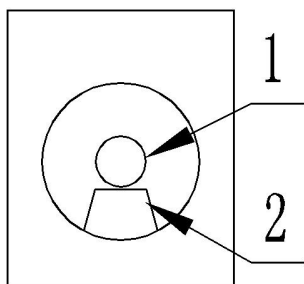

Figure 2-6 Power interface

The pin assignment is as below:

| Pin No. | Signal |
|---------|--------|
| 1 | +24VDC |
| 2 | Ground |

2.4 Buttons and Indicators

There is one FEED button, one inner buzzers, one speaker (optional) and four indicators in SP-POS8810 printer.

【FEED】 is paper feeding button, the function of its enabling or disabling the button on/off can be set by print command, when the button is enabled, press **【FEED】** button, then the paper

presenting driver starts up and paper fed into the printer; release **【FEED】** button, paper feeding stops.

The buzzer indicates the error status type, which can be set to enabling error alarm or disabling by parameter setting. Error status type is the same as error indicator. The incoming order detection prompt is an orange indicator.

The speaker prompts the printer status by voice, such as turning on the [cover], out of paper, high temperature of the print head, high/low voltage, incoming order, etc. The machine with a speaker needs to turn on the voice function through settings. This model didn't support buzzer.

The green POWER indicator is the power indicator. The POWER indicator lights, it indicate that the printer is turned on.

The red PAPER indicator is the paper status indicator. The indicator light indicates that the printer is out of paper.

The blue PAPER indicator is the connection status indicator. The indicator light flashes to indicate that the WIFI is configuring the network, and the steady light indicates that the WIFI or Bluetooth is successfully configured.

The red ERROR indicator is an error status indicator. When the printer is working normally, the red ERROR indicator is off. When the indicator is on, it means that the cover is opened during non-printing. The orange warning light flashes to indicate that the order has not been taken or the order has come to remind.

The orange indicator flashes and the buzzer sounds 3 times: reminding the order.

When the error indicator flashes and the buzzer rings, it means there is an error in the printer.

According to different flashing methods, indicate the type of printer error:

1. Unrecoverable errors. The number of flashes of the indicator light and the number of buzzers indicate the type of error, and it will stay on for a period of time.
2. The error can be recovered. The number of flashes of the indicator light and the number of buzzers indicate the type of error, and then it will stay off for a while.







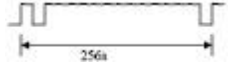

3. Automatic recovery of errors, the indicator light flashes continuously, and the buzzer sounds continuously.

4. When there is no paper, the paper short light will be on and the buzzer will beep for a long time. When the printer paper compartment cover is opened, it will no longer detect whether the printer is out of paper, but only detect whether there is paper.

The error indication is as follows

The details are as below:

① Non-recoverable error, the indicator flickers several times, then persistent lighting. The times of flickering means the error type,

| ERROR Type | ERROR Description | ERROR Indicator Flickering Type |
|-----------------------|--|---|
| Non-recoverable error | LED Flickers once: Internal memory reading and writing error |  |
| | LED Flickers twice: over-voltage |  |
| | LED Flickers three times: under-voltage |  |
| | LED Flickers four times: CPU execution error (wrong address) |  |
| | LED Flickers five times: UIB error |  |
| | LED Flickers six times: FLASH writing error |  |
| | LED Flickers seven times: parameter writing error |  |
| | LED Flickers eight times: Temperature testing circuit error |  |

② Recoverable error, indicator flickers constantly, then persistent off for one period.

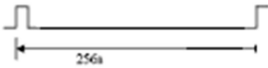
| ERROR Type | ERROR Description | ERROR Indicator Flickering Type |
|-------------------|--|--|
| Recoverable error | LED Flickers once: Cutter position error |  |

③ Auto-recoverable error, indicator flickers constantly, including printing head over-heat error

and upper case cover opening error during printing.

| ERROR Type | ERROR Description | ERROR Indicator Flickering Type |
|------------------------|--|---|
| Auto-recoverable error | LED Flickers constantly: printing head over-heat; upper case cover opening error during printing |  |

2.5 Power on status

Paper cover close when power off. Press the power button, the error indicator and paper out indicator flash twice alternately and out, then printer will be on the normal working mode.

2.6 Self-test

The self-test will check the condition of printer, if the printer prints out the self-test receipt correctly, it means the printer works normally, except interface with host. Otherwise it needs to repair. The self-test will print out the name of manufacturer, printer type, interface type and printer defaulted parameter, 96 characters in ASCII and defaulted Code page content(the language is English) or the name of Chinese characters library(if the language is Chinese) and Bar code type.

Way of self-test: hold down **【FEED】** button and turn on the power, release the button after the error indicator and the out of paper indicator flash alternately twice. self-test begins automatically at this moment.as Fig.2-7 shows

*** 自检页 ***

制造商: SPRT
型号: POS8810
BF版本号: Ver 0.01
版本号: M-769 0.01
接口: 以太网口,USB,蓝牙
以太网参数:
服务端口:
 数据端口: 9100
 网页端口: 80
网络参数:
 DHCP: 禁止
 MAC 地址: 00-2e-f2-39-30-33
 IP 地址: 192.168.1.114
 子网掩码: 255.255.255.0
 网关: 192.168.1.1
蓝牙参数:
 蓝牙版本: 4.3.2,FSC-BT826E
 蓝牙名称: POS8810 Printer
 蓝牙地址: DC:0D:30:00:18:E5
 设备类型: 040680
 蓝牙密码: 1234
 密码使能: 是
语言: 中文
字体: 12*24
打印宽度: 72mm
打印浓度: 中
打印速度: 160mm/S
切刀: 有
蜂鸣器设置: 错误允许
黑标设置: 关
单据检测设置: 开
未取纸设置: 开
纸传感器灵敏度: 中
语音设置: 开
音量: 4
打印方向: 正向
代码页: CP437
产品信息: (S1)611
!"#\$%&'()*+,-./0123456789:;<=>?@ABCDEFGHIJKLMNO
PQRSTUVWXYZ[\]^_`abcdefghijklmnopqrstuvwxyz{|}~
GB 18030 汉字库
条码类型:
1D: UPCA,UPCE,EAN13,EAN8,CODE39
 ITF25,CODABAR,CODE93,CODE128
2D: PDF417,QR CODE,DATA Matrix

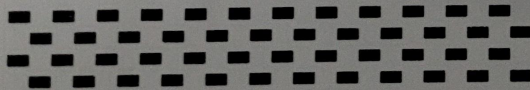

*** 自检打印结束 ***

Fig.2-7

2.7 Hexadecimal Printing

Turn on the printer according to the step below, it will enter the mode of Hexadecimal Printing

1. Open the cover;
2. Hold down **【FEED】** button, and connect with power;
3. Close the cover, the printer will print out 3 lines as below:

Hexadecimal Dump

To terminate hexadecimal dump,
Press FEED button three times.

This means the printer has entered hexadecimal printing mode, and under this mode, all of the input will be printed out as hexadecimal number, feed one line with single-click of “FEED” button, after 3 times, it will print out “*** Completed ***”, and exit hexadecimal printing mode.

2.8 Parameter Setting

This function is to set some simple parameters of the printer.

1. Use the setting tool to set up on the PC.
2. Set by pressing the keys, the specific operation method is as follows.

Enter parameter setting method:

In the shutdown state, first open the [Face], press and hold the [FEED] key, then turn on the power switch, and release the [FEED] key after the status indicator and the out of paper indicator flash alternately. Press the [FEED] key twice, and then close the [Face Shell]. The printer enters the parameter setting mode. And print out the first settable parameter and its current set value. Please refer to Appendix A for detailed setting methods.

Exit the parameter setting method: first open the [face shell], then press the [FEED] key, then close the [face shell] and release the [FEED] key to save the set parameter value and exit the parameter setting mode. Enter normal working mode.

If the printer is turned off directly, the set parameter values will not be saved.

2.9 Enter the program upgrade mode

- a. Press buttons to enter:

In the power off state, first open the upper case, press and hold the [FEED] key, then turn on the

power switch, and release the [FEED] key after the status indicator and the out of paper indicator flash alternately. Then press the [FEED] key five times, and then close the upper case. The printer enters the program upgrade mode. At this time, the red [PAPER] indicator flashes at a rate of about 1 second. Use the "UpdateFirmware.exe" (PC-side upgrade tool) upgrade tool to upgrade.

b. Upgrade in normal working mode:

Connect the USB data cable to the computer, and the printer is turned on normally and there is no abnormal alarm. At this time, it can be upgraded through the PC-side upgrade tool.

1. Open the "UpdateFirmware.exe" upgrade tool.
2. Select the USB port, open the port, select the "firmware file" that needs to be upgraded, and click "start upgrade". When the data is updated, the printer automatically enters the upgrade mode.
3. The red [PAPER] indicator will enter a flashing state of on for 1s and then off for 1s. After the upgrade is completed, the printer will automatically print out the self-checking sample and enter the normal working mode.

Chapter 3 Printer Driver Installation

Please download the SP-POS8810 series printer driver from our official website (www.sprt-printer.com). Specific link: Homepage-Service-Download-Driver-Windows Driver; after downloading, the driver is named SP-DRV211. In the process of installing the driver, the printer model is selected as "80mm thermal series". For other operations, please refer to the installation instructions.

Appendix A

This appendix is a method of setting the default parameters of the printer by pressing the keys.

Setting description: Use the opening and closing **【face】**(trigger button) to select the setting item, every time you open and close the **【face】**, the setting item will be changed to the next item, and the current setting value of the item will be printed out. Use the **【FEED】** key to select the setting value of the setting item. Each time you press the **【FEED】** key, the setting value of the item will change to the lower value.

Total settings:

General Setting:

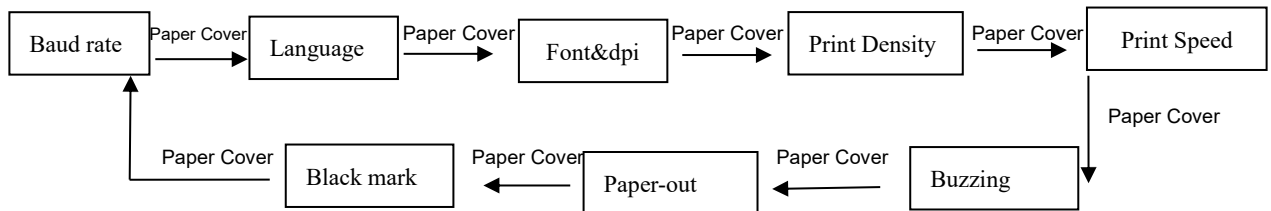

Baud rate:

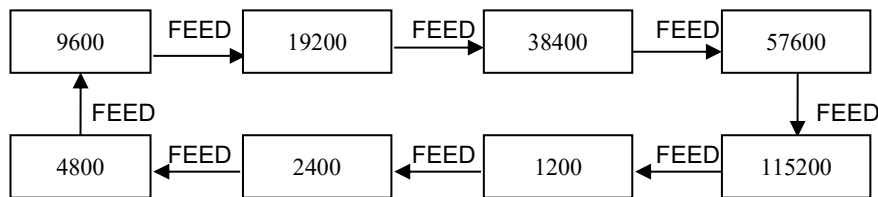

Language:

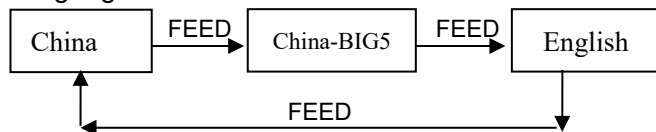

Font&dpi:

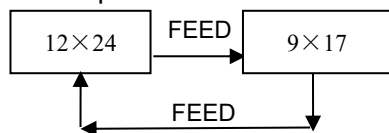

Print Density:

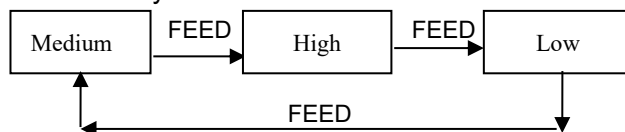

Print Speed:



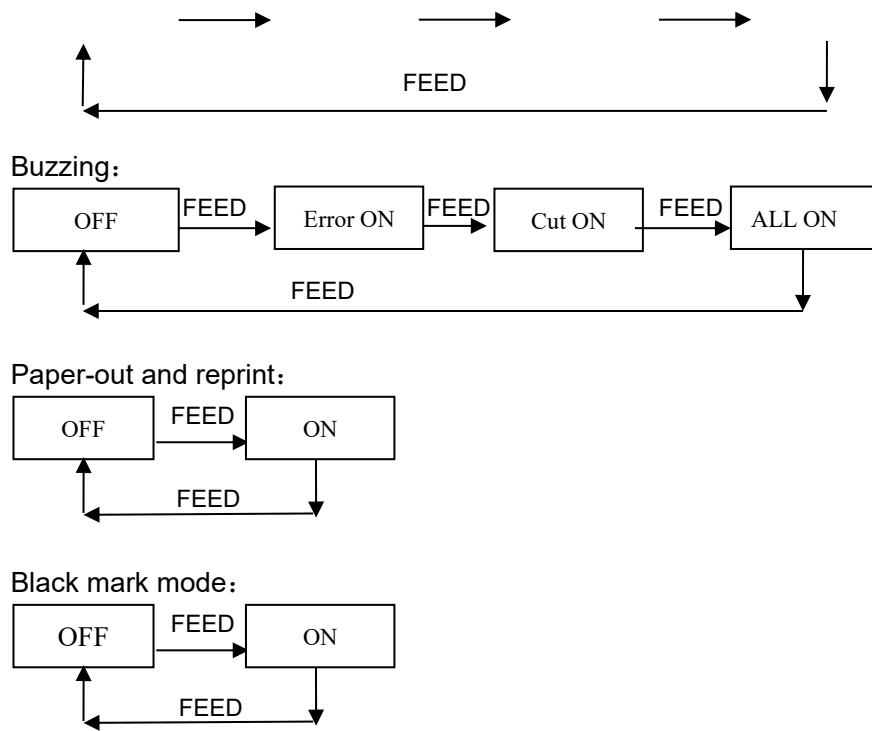

Appendix B: Pre-printed black mark description

If the user uses the pre-printed black mark for bill positioning, the following black mark pre-printing specifications must be followed when printing the black mark, otherwise the printer may not be able to recognize the black mark. Black label pre-printing specifications:

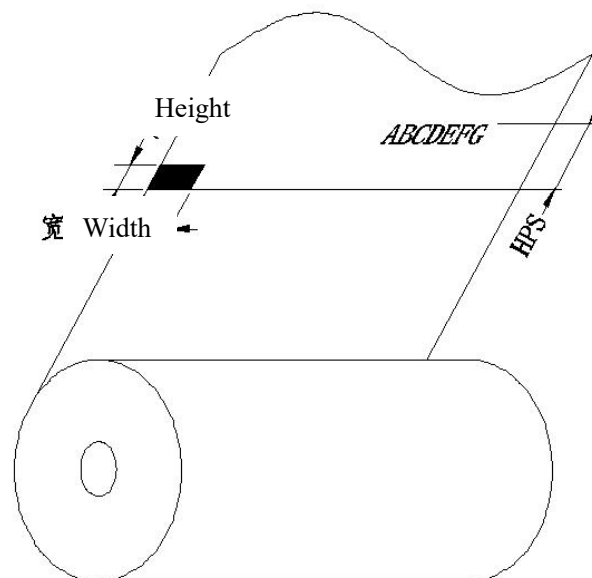

Printing position: As shown in the figure above, the black mark should be printed on the left edge

of the non-text side.

Width range: $\text{width} \geq 12\text{mm}$

Height range: $4\text{mm} \leq \text{height} \leq 6\text{mm}$

Reflectance to infrared light: $<10\%$ (Reflectivity to infrared light in other parts of the black mark width of the paper $>65\%$)

Hps: Hps is the distance between the upper edge of the black mark of the printer and the upper edge of the printing start.

$4.5\text{mm} \leq \text{Hps} \leq 6.5\text{mm}$ ($\approx 5.3\text{mm}$)

The manufacturer has the right to modify the content of the manual without making a prior statement!

The final interpretation right belongs to SPRT!